



ENTRANCE & WINDOW SYSTEMS





ENTRANCE & WINDOW SYSTEMS

NOTICE :

PL PREMIUM ADHESIVE MUST BE USED ON ALL BEDDING/BUTT JOINTS.

SPECTIS RESERVES THE RIGHT TO HOLLOW OUT BACK OF ANY PRODUCTS WITHOUT NOTICE.

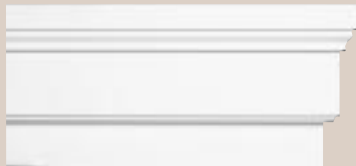

CSH 1004 (See MD 1004 on page 138)
• 3 1/2" Projection • 12 3/4" Height • Matches K 2708



CSH 1006 (See MD 1006 on page 132)
• 5" Projection • 14" Height • Matches K 2717



CSH 1015 (See MD 1015 on page 132)
• 4 1/4" Projection • 9 3/8" Height • Matches K 2700

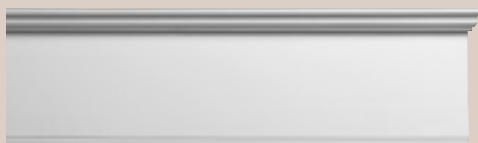

CSH 1018 (See MD 1018 on page 148)
• 1 1/2" Projection • 9" Height • Matches K 2716

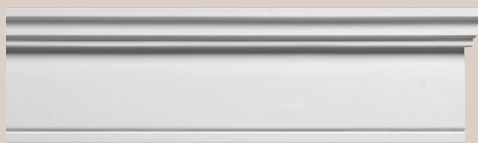

CSH 1025 (See MD 1025 on page 137)
• 1 1/2" Projection • 5 1/2" Height • Matches K 2703

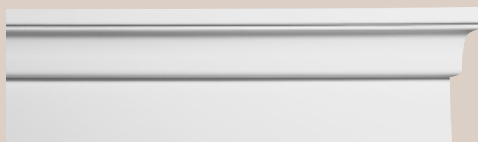

CSH 1035 (See MD 1035 on page 131)
• 3" Projection • 9" Height • Matches K 2701



CSH 1038 (See MD 1038 on page 118)
• 5 3/4" Projection • 8 5/8" Height



CSH 1052 (See MD 1052 on page 131)
• 3 3/4" Projection • 6" Height • Matches K 2702



CSH 1142 (See MD 1142 on page 132)
• 6" Projection • 7" Height • Matches K 2718

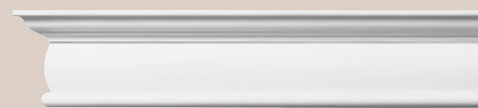

CSH 1158 (See MD 1158 on page 130)
• 3" Projection • 5" Height • Matches K 2719

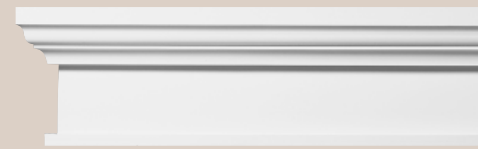

CSH 1252 (See MD 1252 on page 132)
• 4" Projection • 10" Height • Matches K 2715

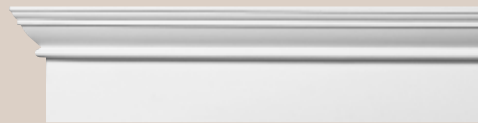

CSH 1267 (See MD 1267 on page 130)
• 2 7/8" Projection • 6" Height • Matches K 2714



CSH 1316 (See MD 1316 on page 118)
• 4 1/4" Projection • 9 3/8" Height

WINDOW HEADERS

1 • 8 0 0 • 6 8 5 • 9 9 8 1



ENTRANCE & WINDOW SYSTEMS



ALL HEADERS COME WITH RETURNED ENDS.

Keystones available on page 77 and 78.
See window header size charts on page 65 and 66.

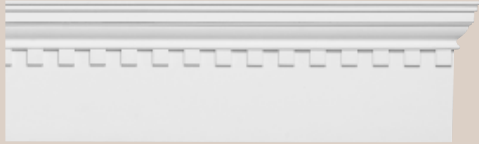

CSH 1335 (See MD 1335 on page 132)
• 4" Projection • 9 1/4" Height

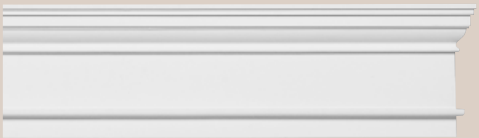

CSH 1336 (See MD 1336 on page 132)
• 4" Projection • 9 1/4" Height • Matches K 2720

WINDOW HEADERS

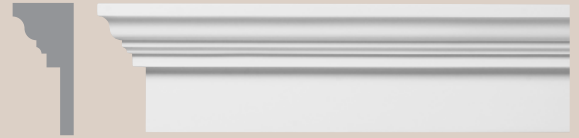

CSH 1354 (See MD 1354 on page 130)
• 4 1/2" Projection • 9 3/4" Height • Matches K 2727



CSH 1403 (See MD 1403 on page 131)
• 4 1/2" Projection • 12" Height

WINDOW HEADER SIZE CHART

SIZE	CSH 1004	CSH 1006	CSH 1015	CSH 1018	CSH 1025	CSH 1035	CSH 1038	CSH 1052	CSH 1142
24"	CSH 1004-24	CSH 1006-24	CSH 1015-24	CSH 1018-24	CSH 1025-24	CSH 1035-24	CSH 1038-24	CSH 1052-24	CSH 1142-24
28"	CSH 1004-28	CSH 1006-28	CSH 1015-28	CSH 1018-28	CSH 1025-28	CSH 1035-28	CSH 1038-28	CSH 1052-28	CSH 1142-28
30"	CSH 1004-30	CSH 1006-30	CSH 1015-30	CSH 1018-30	CSH 1025-30	CSH 1035-30	CSH 1038-30	CSH 1052-30	CSH 1142-30
32"	CSH 1004-32	CSH 1006-32	CSH 1015-32	CSH 1018-32	CSH 1025-32	CSH 1035-32	CSH 1038-32	CSH 1052-32	CSH 1142-32
36"	CSH 1004-36	CSH 1006-36	CSH 1015-36	CSH 1018-36	CSH 1025-36	CSH 1035-36	CSH 1038-36	CSH 1052-36	CSH 1142-36
40"	CSH 1004-40	CSH 1006-40	CSH 1015-40	CSH 1018-40	CSH 1025-40	CSH 1035-40	CSH 1038-40	CSH 1052-40	CSH 1142-40
42"	CSH 1004-42	CSH 1006-42	CSH 1015-42	CSH 1018-42	CSH 1025-42	CSH 1035-42	CSH 1038-42	CSH 1052-42	CSH 1142-42
44"	CSH 1004-44	CSH 1006-44	CSH 1015-44	CSH 1018-44	CSH 1025-44	CSH 1035-44	CSH 1038-44	CSH 1052-44	CSH 1142-44
48"	CSH 1004-48	CSH 1006-48	CSH 1015-48	CSH 1018-48	CSH 1025-48	CSH 1035-48	CSH 1038-48	CSH 1052-48	CSH 1142-48
52"	CSH 1004-52	CSH 1006-52	CSH 1015-52	CSH 1018-52	CSH 1025-52	CSH 1035-52	CSH 1038-52	CSH 1052-52	CSH 1142-52
56"	CSH 1004-56	CSH 1006-56	CSH 1015-56	CSH 1018-56	CSH 1025-56	CSH 1035-56	CSH 1038-56	CSH 1052-56	CSH 1142-56
60"	CSH 1004-60	CSH 1006-60	CSH 1015-60	CSH 1018-60	CSH 1025-60	CSH 1035-60	CSH 1038-60	CSH 1052-60	CSH 1142-60
64"	CSH 1004-64	CSH 1006-64	CSH 1015-64	CSH 1018-64	CSH 1025-64	CSH 1035-64	CSH 1038-64	CSH 1052-64	CSH 1142-64
68"	CSH 1004-68	CSH 1006-68	CSH 1015-68	CSH 1018-68	CSH 1025-68	CSH 1035-68	CSH 1038-68	CSH 1052-68	CSH 1142-68
72"	CSH 1004-72	CSH 1006-72	CSH 1015-72	CSH 1018-72	CSH 1025-72	CSH 1035-72	CSH 1038-72	CSH 1052-72	CSH 1142-72
74"	CSH 1004-74	CSH 1006-74	CSH 1015-74	CSH 1018-74	CSH 1025-74	CSH 1035-74	CSH 1038-74	CSH 1052-74	CSH 1142-74
76"	CSH 1004-76	CSH 1006-76	CSH 1015-76	CSH 1018-76	CSH 1025-76	CSH 1035-76	CSH 1038-76	CSH 1052-76	CSH 1142-76
78"	CSH 1004-78	CSH 1006-78	CSH 1015-78	CSH 1018-78	CSH 1025-78	CSH 1035-78	CSH 1038-78	CSH 1052-78	CSH 1142-78
80"	CSH 1004-80	CSH 1006-80	CSH 1015-80	CSH 1018-80	CSH 1025-80	CSH 1035-80	CSH 1038-80	CSH 1052-80	CSH 1142-80
84"	CSH 1004-84	CSH 1006-84	CSH 1015-84	CSH 1018-84	CSH 1025-84	CSH 1035-84	CSH 1038-84	CSH 1052-84	CSH 1142-84
92"	CSH 1004-92	CSH 1006-92	CSH 1015-92	CSH 1018-92	CSH 1025-92	CSH 1035-92	CSH 1038-92	CSH 1052-92	CSH 1142-92
96"	CSH 1004-96	CSH 1006-96	CSH 1015-96	CSH 1018-96	CSH 1025-96	CSH 1035-96	CSH 1038-96	CSH 1052-96	CSH 1142-96
100"	CSH 1004-100	CSH 1006-100	CSH 1015-100	CSH 1018-100	CSH 1025-100	CSH 1035-100	CSH 1038-100	CSH 1052-100	CSH 1142-100
104"	CSH 1004-104	CSH 1006-104	CSH 1015-104	CSH 1018-104	CSH 1025-104	CSH 1035-104	CSH 1038-104	CSH 1052-104	CSH 1142-104
108"	CSH 1004-108	CSH 1006-108	CSH 1015-108	CSH 1018-108	CSH 1025-108	CSH 1035-108	CSH 1038-108	CSH 1052-108	CSH 1142-108
112"	CSH 1004-112	CSH 1006-112	CSH 1015-112	CSH 1018-112	CSH 1025-112	CSH 1035-112	CSH 1038-112	CSH 1052-112	CSH 1142-112
124"	CSH 1004-124	CSH 1006-124	CSH 1015-124	CSH 1018-124	CSH 1025-124	CSH 1035-124	CSH 1038-124	CSH 1052-124	CSH 1142-124





ENTRANCE & WINDOW SYSTEMS

NOTICE :

PL PREMIUM ADHESIVE MUST BE USED ON ALL BEDDING/BUTT JOINTS.

FINISHING

All Spectis' products are shipped "double primed" with an exterior grade latex and are ready for use. We recommend final finishing after installation is complete for the most consistent appearance possible. Please see "finishing" recommendations (on page 175) for more information.



Photo above illustrates the following Spectis products: custom size header CSH 1038, and moulding MD 1243.

WINDOW HEADER SIZE CHART (continued)

SIZE	CSH 1158	CSH 1252	CSH 1267	CSH 1316	CSH 1335	CSH 1336	CSH 1354	CSH 1403
24"	CSH 1158-24	CSH 1252-24	CSH 1267-24	CSH 1316-24	CSH 1335-24	CSH 1336-24	CSH 1354-24	CSH 1403-24
28"	CSH 1158-28	CSH 1252-28	CSH 1267-28	CSH 1316-28	CSH 1335-28	CSH 1336-28	CSH 1354-28	CSH 1403-28
30"	CSH 1158-30	CSH 1252-30	CSH 1267-30	CSH 1316-30	CSH 1335-30	CSH 1336-30	CSH 1354-30	CSH 1403-30
32"	CSH 1158-32	CSH 1252-32	CSH 1267-32	CSH 1316-32	CSH 1335-32	CSH 1336-32	CSH 1354-32	CSH 1403-32
36"	CSH 1158-36	CSH 1252-36	CSH 1267-36	CSH 1316-36	CSH 1335-36	CSH 1336-36	CSH 1354-36	CSH 1403-36
40"	CSH 1158-40	CSH 1252-40	CSH 1267-40	CSH 1316-40	CSH 1335-40	CSH 1336-40	CSH 1354-40	CSH 1403-40
42"	CSH 1158-42	CSH 1252-42	CSH 1267-42	CSH 1316-42	CSH 1335-42	CSH 1336-42	CSH 1354-42	CSH 1403-42
44"	CSH 1158-44	CSH 1252-44	CSH 1267-44	CSH 1316-44	CSH 1335-44	CSH 1336-44	CSH 1354-44	CSH 1403-44
48"	CSH 1158-48	CSH 1252-48	CSH 1267-48	CSH 1316-48	CSH 1335-48	CSH 1336-48	CSH 1354-48	CSH 1403-48
52"	CSH 1158-52	CSH 1252-52	CSH 1267-52	CSH 1316-52	CSH 1335-52	CSH 1336-52	CSH 1354-52	CSH 1403-52
56"	CSH 1158-56	CSH 1252-56	CSH 1267-56	CSH 1316-56	CSH 1335-56	CSH 1336-56	CSH 1354-56	CSH 1403-56
60"	CSH 1158-60	CSH 1252-60	CSH 1267-60	CSH 1316-60	CSH 1335-60	CSH 1336-60	CSH 1354-60	CSH 1403-60
64"	CSH 1158-64	CSH 1252-64	CSH 1267-64	CSH 1316-64	CSH 1335-64	CSH 1336-64	CSH 1354-64	CSH 1403-64
68"	CSH 1158-68	CSH 1252-68	CSH 1267-68	CSH 1316-68	CSH 1335-68	CSH 1336-68	CSH 1354-68	CSH 1403-68
72"	CSH 1158-72	CSH 1252-72	CSH 1267-72	CSH 1316-72	CSH 1335-72	CSH 1336-72	CSH 1354-72	CSH 1403-72
74"	CSH 1158-74	CSH 1252-74	CSH 1267-74	CSH 1316-74	CSH 1335-74	CSH 1336-74	CSH 1354-74	CSH 1403-74
76"	CSH 1158-76	CSH 1252-76	CSH 1267-76	CSH 1316-76	CSH 1335-76	CSH 1336-76	CSH 1354-76	CSH 1403-76
78"	CSH 1158-78	CSH 1252-78	CSH 1267-78	CSH 1316-78	CSH 1335-78	CSH 1336-78	CSH 1354-78	CSH 1403-78
80"	CSH 1158-80	CSH 1252-80	CSH 1267-80	CSH 1316-80	CSH 1335-80	CSH 1336-80	CSH 1354-80	CSH 1403-80
84"	CSH 1158-84	CSH 1252-84	CSH 1267-84	CSH 1316-84	CSH 1335-84	CSH 1336-84	CSH 1354-84	CSH 1403-84
92"	CSH 1158-92	CSH 1252-92	CSH 1267-92	CSH 1316-92	CSH 1335-92	CSH 1336-92	CSH 1354-92	CSH 1403-92
96"	CSH 1158-96	CSH 1252-96	CSH 1267-96	CSH 1316-96	CSH 1335-96	CSH 1336-96	CSH 1354-96	CSH 1403-96
100"	CSH 1158-100	CSH 1252-100	CSH 1267-100	CSH 1316-100	CSH 1335-100	CSH 1336-100	CSH 1354-100	CSH 1403-100
104"	CSH 1158-104	CSH 1252-104	CSH 1267-104	CSH 1316-104	CSH 1335-104	CSH 1336-104	CSH 1354-104	CSH 1403-104
108"	CSH 1158-108	CSH 1252-108	CSH 1267-108	CSH 1316-108	CSH 1335-108	CSH 1336-108	CSH 1354-108	CSH 1403-108
112"	CSH 1158-112	CSH 1252-112	CSH 1267-112	CSH 1316-112	CSH 1335-112	CSH 1336-112	CSH 1354-112	CSH 1403-112
124"	CSH 1158-124	CSH 1252-124	CSH 1267-124	CSH 1316-124	CSH 1335-124	CSH 1336-124	CSH 1354-124	CSH 1403-124

1 • 8 0 0 • 6 8 5 • 9 9 8 1



ENTRANCE & WINDOW SYSTEMS



PEDIMENTS

ACORN PEDIMENT		SUNBURST PEDIMENT		PEAKED PEDIMENT		RAMS HEAD PEDIMENT	
AP 5315	AP 8421	SP 5315	SP 8423	PP 5314	PP 8421	RH 5319	RH 8424
AP 5716	AP 9023	SP 5716	SP 9021	PP 5715	PP 9023	RH 5718	RH 9024
AP 7018	AP 9823	SP 7018	SP 9825	PP 7018	PP 9825	RH 7022	RH 9826

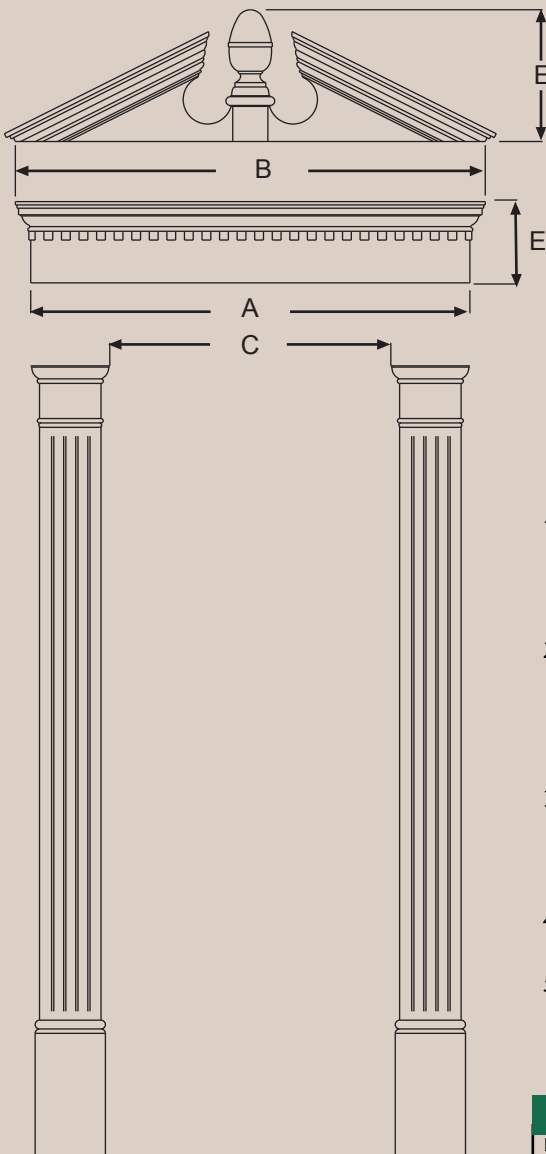

PEDIMENTS

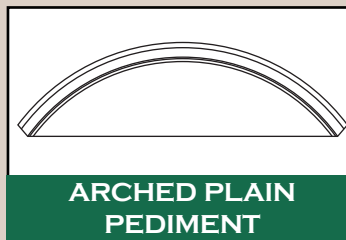

ARCHED PLAIN PEDIMENT

APP 5315 APP 8423
 APP 5716 APP 9021
 APP 7018 APP 9825

CROSSHEADS

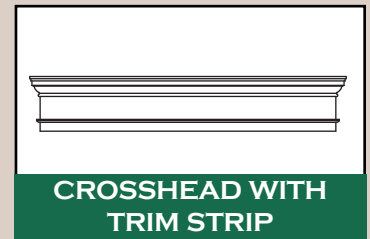

CROSSHEAD WITH TRIM STRIP

CHT 5009 CHT 8109
 CHT 5409 CHT 8309
 CHT 6609 CHT 8609
 CHT 7809 CHT 9409

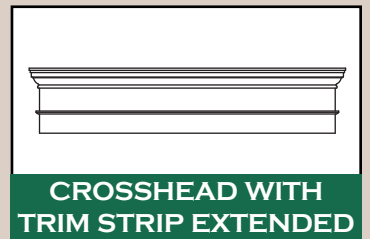

CROSSHEAD WITH TRIM STRIP EXTENDED

CHT 5011 CHT 8111
 CHT 5411 CHT 8311
 CHT 6611 CHT 8611
 CHT 7811 CHT 9411

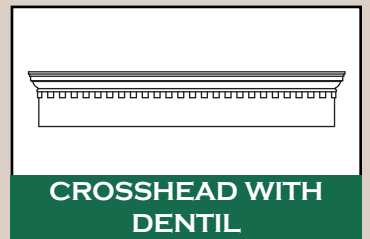

CROSSHEAD WITH DENTIL

CHD 5009 CHD 8109
 CHD 5409 CHD 8309
 CHD 6609 CHD 8609
 CHD 7809 CHD 9409

ENTRANCE SYSTEM INSTRUCTIONS

1. Measure door opening. If the brickmould is to remain on the door frame be sure to take this into account. This will give you the "C" dimension. (Example: 36")
2. On the Entrance system Chart under pilasters locate the "C" dimension size to determine which pilasters to use. (Example 36" you would use 7" pilasters to give you an "A" measurement of 50")
3. Move across the chart to choose the Header you want. Choose the pediment which is directly below. (Example: CHT 5009 & AP 5315)
4. On the pilaster page pick out the style you desire.
5. If your door has sidelights pick out the style of Mull Strip you desire. Note these Mull Strips go between the door and the sidelights.

MULL STRIPS

PRODUCT NUMBER	WIDTH	HEIGHT	PROJECTION
MS 284-F	2"	84"	1 1/8"
MS 284-P	2"	84"	1 1/8"





ENTRANCE & WINDOW SYSTEMS

NOTICE :

PL PREMIUM ADHESIVE MUST BE USED ON ALL BEDDING/BUTT JOINTS.

PILASTERS					ENTRANCE SYSTEM CHART					
5"	6"	7"	8"	9"	DESCRIPTION	PRODUCT NUMBER	"A" WIDTH	"B" WIDTH	PROJECTION	"E" HEIGHT
"C" DIMENSIONS										
40"	38"	36"	34"	32"	Crosshead w/Trim Strip 9 1/4"	CHT 5009	50"		4"	9 1/4"
					Crosshead w/Trim Ex-Strip 11"	CHT 5011	50"		4"	11"
					Crosshead w/Dentil 9 1/4"	CHD 5009	50"		4"	9 1/4"
					Acorn Pediment	AP 5315		53 1/2"	4"	15"
					Sunburst Pediment	SP 5315		53 1/2"	4"	15 7/8"
					Arched Plain Pediment	APP 5315		53 1/2"	4"	15 7/8"
					Peaked Pediment	PP 5314		53 1/2"	4"	14 1/2"
					Rams Head Pediment	RH 5319		53 1/2"	6"	19 1/2"
44"	42"	40"	38"	36"	Crosshead w/Trim Strip 9 1/4"	CHT 5409	54"		4"	9 1/4"
					Crosshead w/Trim Ex-Strip 11"	CHT 5411	54"		4"	11"
					Crosshead w/Dentil 9 1/4"	CHD 5409	54"		4"	9 1/4"
					Acorn Pediment	AP 5716		57"	4 1/2"	16"
					Sunburst Pediment	SP 5716		57"	5"	16"
					Arched Plain Pediment	APP 5716		57"	5"	16"
					Peaked Pediment	PP 5715		57"	4 1/2"	15 1/4"
					Rams Head Pediment	RH 5718		57"	6"	18 1/2"
56"	54"	52"	50"	48"	Crosshead w/Trim Strip 9 1/4"	CHT 6609	66"		4"	9 1/4"
					Crosshead w/Trim Ex-Strip 11"	CHT 6611	66"		4"	11"
					Crosshead w/Dentil 9 1/4"	CHD 6609	66"		4"	9 1/4"
					Acorn Pediment	AP 7018		70 1/4"	4"	18"
					Sunburst Pediment	SP 7018		70 1/4"	6"	18 1/4"
					Arched Plain Pediment	APP 7018		70 1/4"	6"	18 1/4"
					Peaked Pediment	PP 7018		70 1/4"	4"	18 1/4"
					Rams Head Pediment	RH 7022		70 1/4"	5 1/8"	22 3/8"
68 3/4"	66 3/4"	64 3/4"	62 3/4"	60 3/4"	Crosshead w/Trim Strip 9 1/4"	CHT 7809	78 3/4"		4"	9 1/4"
					Crosshead w/Trim Ex-Strip 11"	CHT 7811	78 3/4"		4"	11"
					Crosshead w/Dentil 9 1/4"	CHD 7809	78 3/4"		4"	9 1/4"
71"	69"	67"	65"	63"	Crosshead w/Trim Strip 9 1/4"	CHT 8109	81"		4"	9 1/4"
					Crosshead w/Trim Ex-Strip 11"	CHT 8111	81"		4"	11"
					Crosshead w/Dentil 9 1/4"	CHD 8109	81"		4"	9 1/4"
					Acorn Pediment	AP 8421		84 1/2"	4"	21 1/2"
					Sunburst Pediment	SP 8423		84 1/2"	6"	23 3/4"
					Arched Plain Pediment	APP 8423		84 1/2"	6"	23 3/4"
					Peaked Pediment	PP 8421		84 1/2"	4"	21 1/4"
					Rams Head Pediment	RH 8424		84 1/2"	6"	24"
73"	71"	69"	67"	65"	Crosshead w/Trim Strip 9 1/4"	CHT 8309	83"		4"	9 1/4"
					Crosshead w/Trim Ex-Strip 11"	CHT 8311	83"		4"	11"
					Crosshead w/Dentil 9 1/4"	CHD 8309	83"		4"	9 1/4"
76 3/4"	74 3/4"	72 3/4"	70 3/4"	68 3/4"	Crosshead w/Trim Strip 9 1/4"	CHT 8609	86 3/4"		4"	9 1/4"
					Crosshead w/Trim Ex-Strip 11"	CHT 8611	86 3/4"		4"	11"
					Crosshead w/Dentil 9 1/4"	CHD 8609	86 3/4"		4"	9 1/4"
					Acorn Pediment	AP 9023		90"	4 1/2"	23 1/8"
					Sunburst Pediment	SP 9021		90"	6"	21 1/8"
					Arched Plain Pediment	APP 9021		90"	6"	21 1/8"
					Peaked Pediment	PP 9023		90"	4 1/2"	23"
					Rams Head Pediment	RH 9024		90"	6"	24 3/4"
84 3/4"	82 3/4"	80 3/4"	78 3/4"	76 3/4"	Crosshead w/Trim Strip 9 1/4"	CHT 9409	94 3/4"		4"	9 1/4"
					Crosshead w/Trim Ex-Strip 11"	CHT 9411	94 3/4"		4"	11"
					Crosshead w/Dentil 9 1/4"	CHD 9409	94 3/4"		4"	9 1/4"
					Acorn Pediment	AP 9823		98"	4"	23 7/16"
					Sunburst Pediment	SP 9825		98"	7"	25 1/4"
					Arched Plain Pediment	APP 9825		98"	7"	25 1/4"
					Peaked Pediment	PP 9825		98"	4"	25 1/2"
					Rams Head Pediment	RH 9826		98"	7"	26 3/4"

1 • 800 • 685 • 9981



ENTRANCE & WINDOW SYSTEMS

COMBINED PEDIMENT & CROSSHEAD

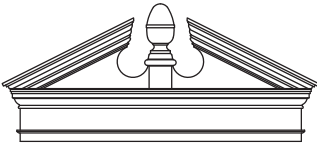

CAPT
COMBINED ACORN
PEDIMENT/CROSSHEAD
WITH TRIM STRIP

See diagram on page 67 for location of dimensions "A", "B", "C" and "E".

For selection of pilaster styles refer to pages 70 and 71.



CAPD
COMBINED ACORN
PEDIMENT/CROSSHEAD
WITH DENTIL



CPPT
COMBINED PEAKED
PEDIMENT/CROSSHEAD
WITH TRIM STRIP

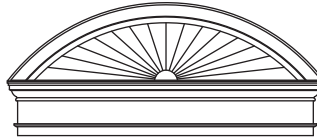

CSPT
COMBINED SUNBURST
PEDIMENT/CROSSHEAD
WITH TRIM STRIP



CPPD
COMBINED PEAKED
PEDIMENT/CROSSHEAD
WITH DENTIL

ENTRANCE SYSTEM CHART- Combined Pediments - One Piece

PILASTERS					DESCRIPTION	PRODUCT NUMBER	PITCH	"A" WIDTH	"B" WIDTH	PROJECTION	"E" HEIGHT
5"	6"	7"	8"	9"							
"C" DIMENSIONS											
COMBINED PEDIMENTS WITH CROSSHEADS FOR SINGLE DOOR OPENINGS											
40"	38"	36"	34"	32"	Acorn Pediment/Crosshead	CAPT 5023	6/12	50"	53 1/2"	4"	23"
					Acorn Pediment/Dentil Crosshead	CAPD 5023	6/12			4"	23"
					Sunburst Pediment/Crosshead	CSPT 5025				4"	25 1/8"
					Peaked Pediment/Crosshead	CPPT 5023	6.5/12			4"	23 3/4"
					Peaked Pediment/Dentil Crosshead	CPPD 5023	6.5/12			4"	23 3/4"
44"	42"	40"	38"	36"	Acorn Pediment/Crosshead	CAPT 5423	6/12	54"	56 1/2"	4"	23 3/4"
					Acorn Pediment/Dentil Crosshead	CAPD 5423	6/12			4"	23 3/4"
					Sunburst Pediment/Crosshead	CSPT 5425				5"	25"
					Peaked Pediment/Crosshead	CPPT 5424	6.5/12			4"	24 1/2"
					Peaked Pediment/Dentil Crosshead	CPPD 5424	6.5/12			4"	24 1/2"
COMBINED PEDIMENTS WITH CROSSHEADS FOR DOUBLE DOOR OPENINGS AND TWO SIDELIGHTS											
68 3/4"	66 3/4"	64 3/4"	62 3/4"	60 3/4"	Acorn Pediment/Crosshead	CAPT 7930	6/12	78 3/4"	84 1/2"	4"	30 3/4"
					Sunburst Pediment/Crosshead	CSPT 7930				6"	33"
					Peaked Pediment/Crosshead	CPPT 7930	7.5/12			4"	30 1/2"
71"	69"	67"	65"	63"	Acorn Pediment/Crosshead	CAPT 8130	6/12	81"	84 1/2"	4"	30 3/4"
					Sunburst Pediment/Crosshead	CSPT 8130				6"	33"
					Peaked Pediment/Crosshead	CPPT 8130	7/12			4"	30 1/2"
73"	71"	69"	67"	65"	Acorn Pediment/Crosshead	CAPT 8330	6/12	83"	90"	4"	30 1/2"
					Sunburst Pediment/Crosshead	CSPT 8333				6"	33"
					Peaked Pediment/Crosshead	CPPT 8330	6/12			4"	30 1/2"
76 3/4"	74 3/4"	72 3/4"	70 3/4"	68 3/4"	Acorn Pediment/Crosshead	CAPT 8732	6/12	86 3/4"	90"	4"	32 3/8"
					Sunburst Pediment/Crosshead	CSPT 8730				6"	30 3/8"
					Peaked Pediment/Crosshead	CPPT 8732	7/12			4"	32 1/4"





ENTRANCE & WINDOW SYSTEMS

NOTICE :

PL PREMIUM ADHESIVE MUST BE USED ON ALL BEDDING/BUTT JOINTS.

PILASTERS



1

FLUTED PILASTER

- PL 452 F • 2 1/4" p. x 51 3/4" h. x 4 9/16" w.
- PL 590 F • 2 1/4" p. x 90" h. x 5" w.
- PL 690 F • 2 1/4" p. x 90" h. x 6" w.
- PL 769 F • 2 1/4" p. x 69" h. x 7" w.
- PL 790 F • 2 1/4" p. x 90" h. x 7" w.
- PL 890 F • 2 1/4" p. x 90" h. x 8" w.
- PL 960 F • 2 1/4" p. x 60" h. x 9" w.
- PL 990 F • 2 1/4" p. x 90" h. x 9" w.
- PL 999 F • 2 1/4" p. x 99" h. x 9" w.
- PL 7102 F • 2 1/4" p. x 102" h. x 7" w.
- PL 11108 F • 2 1/4" p. x 108" h. x 11" w.

2

DOUBLE PANEL PILASTER

- PL 590 DP • 2 1/4" p. x 90" h. x 5" w.
- PL 690 DP • 2 1/4" p. x 90" h. x 6" w.
- PL 790 DP • 2 1/4" p. x 90" h. x 7" w.
- PL 890 DP • 2 1/4" p. x 90" h. x 8" w.
- PL 990 DP • 2 1/4" p. x 90" h. x 9" w.
- PL 9102 DP • 2 1/4" p. x 102" h. x 9" w.

3

SINGLE PANEL PILASTER

- PL 590 P • 2 1/4" p. x 90" h. x 5" w.
- PL 690 P • 2 1/4" p. x 90" h. x 6" w.
- PL 790 P • 2 1/4" p. x 90" h. x 7" w.
- PL 890 P • 2 1/4" p. x 90" h. x 8" w.
- PL 990 P • 2 1/4" p. x 90" h. x 9" w.
- PL 1190 P • 2 1/4" p. x 90" h. x 11" w.
- PL 9102 P • 2 1/4" p. x 102" h. x 9" w.

4

SMOOTH PILASTER

- PL 793 SM • 2 1/4" p. x 93" h. x 7" w.

5

LONG FLUTED PILASTER

- PL 490 LF • 1 7/8" p. x 90" h. x 4" w.
- PL 690 LF • 1 7/8" p. x 90" h. x 6" w.

1 • 800 • 685 • 9981



ENTRANCE & WINDOW SYSTEMS



PILASTERS

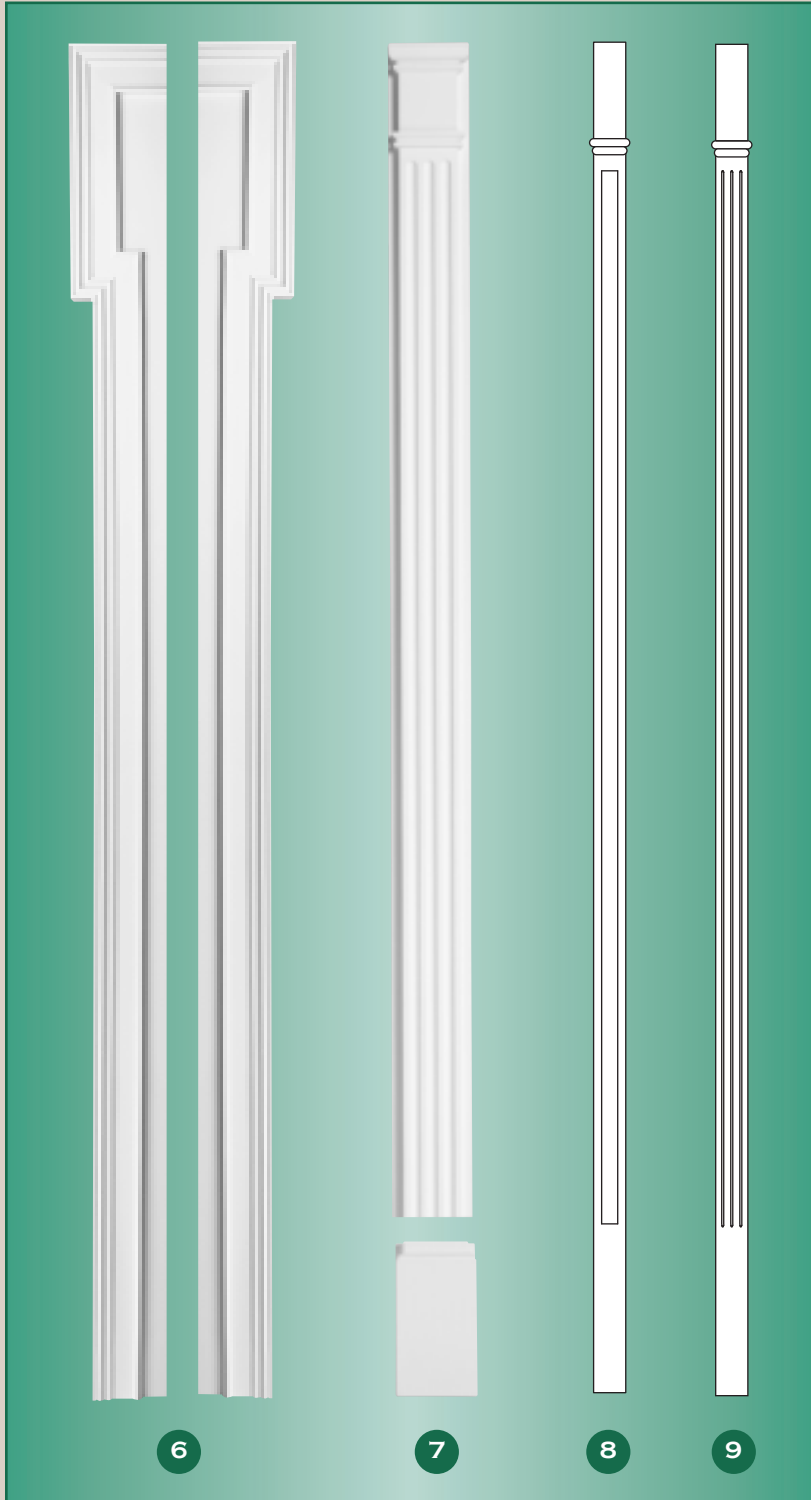

6

PILASTER

PL 1144L • 1 3/4" p. x 96" h.

PL 1144R • 1 3/4" p. x 96" h.

• Matches MD 1144

7

PILASTER • Plinth Block is a separate piece

PL 5108 • 1 5/8" p. x 118 9/16" h. x 5 1/4" w.

PL 6108 • 1 3/4" p. x 118" h. x 6" w.

8

PANEL MULL

PL 284 P • 1 1/8" p. x 84" h. x 2" w.

9

FLUTED MULL

PL 284 F • 1 1/8" p. x 84" h. x 2" w.





ENTRANCE & WINDOW SYSTEMS

NOTICE :

PL PREMIUM ADHESIVE MUST BE USED ON ALL BEDDING/BUTT JOINTS.

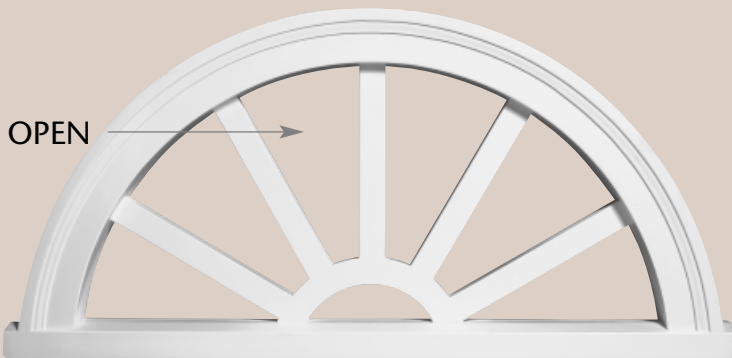

Photo above shows the following Spectis products: sunburst SHC 4824 and rake trim FAC 1382 left and right.



Photo above illustrates the following Spectis products: sunburst HCS 3016, rails RAL 2100 top & bottom and balusters BAL 2014-24.

SUNBURSTS



• 1 3/8" Projection

SHR 2613 • 26" Width • 13" Height

SHR 3819 • 38" Width • 19" Height

SHR 5025 • 50" Width • 25" Height

SHR 6030 • 60" Width • 30" Height



• 1 3/8" Projection

SHC 4424 • 42" Width • 24" Height

SHC 4824 • 48" Width • 24" Height

SHC 5025 • 50" Width • 25" Height

SHC 5828 • 58" Width • 28" Height

SPECTIS EXTERIOR PAINT TOPCOAT

All Spectis' products are shipped "double primed" with an exterior grade latex and are ready for use. We recommend in field finishing after installation is complete for the most consistent appearance possible. Please see "finishing" recommendations (on page 175) for more information.



1 • 8 0 0 • 6 8 5 • 9 9 8 1



SUNBURSTS

ENTRANCE & WINDOW SYSTEMS



• 1 3/4" Projection

SUNBURST	WIDTH	HEIGHT
HSS 2409	24"	9"
HSS 2508	25 5/8"	8 1/4"
HSS 2809	28"	9 3/8"
HSS 2908	29"	8 1/4"
HSS 3009	30"	9 3/8"
HSS 3209	32"	9"
HSS 3309	33"	8 1/4"
HSS 3609	36"	9"
HSS 3612	36"	12"
HSS 3709	37"	9"
HSS 4010	40"	10"
HSS 4110	41"	10"
HSS 4210	42"	10"
HSS 4412	44"	12"
HSS 4812	48"	12"
HSS 5212	52"	12"
HSS 5612	56"	12"
HSS 6013	60"	13"
HSS 6413	64"	13"
HSS 6814	68"	14"
HSS 7214	72"	14"
HSS 7615	76"	15"
HSS 8015	80"	15"
HSS 8415	84"	15"
HSS 8816	88"	16"
HSS 9216	92"	16"
HSS 9617	96"	17"
HSS 10017	100"	17"
* HSS 10210	102"	10"
HSS 10417	104"	17"
HSS 10818	108"	18"
HSS 11218	112"	18"
* HSS 11412	114 1/8"	12 1/2"
HSS 12221	122"	21"
HSS 12622	126"	22"
HSS 13222	132"	22"
HSS 14414	144"	14 1/2"
** HSS 19915	199"	15"

* Garage Door Headers

** Garage Door Header shipped in two pieces.



• 1 3/4" Projection

SUNBURST	WIDTH	HEIGHT
HCS 2413	24"	15"
HCS 2513	25 5/8"	13 7/8"
HCS 2815	28"	15"
HCS 2915	29 5/8"	15 3/4"
HCS 3016	30"	16"
HCS 3217	32"	17"
HCS 3318	33"	18"
HCS 3619	36"	19"
HCS 3720	37"	20"
HCS 4021	40"	21"
HCS 4121	41 5/8"	21 7/8"
HCS 4222	42"	22"
HCS 4423	44"	23"
HCS 4825	48"	25"
HCS 5227	52"	27"
HCS 5629	56"	29"
HCS 6031	60"	31"
HCS 6433	64"	33"
HCS 6835	68"	35"
HCS 7237	72"	37"
HCS 7639	76"	39"
HCS 8041	80"	41"
HCS 8443	84"	43"
HCS 8845	88"	45"
HCS 9247	92"	47"
HCS 9649	96"	49"
HCS 10052	100"	52"
HCS 10454	104"	54"
HCS 10856	108"	56"

CUSTOM SIZES AVAILABLE



Photo above shows the following Spectis products: sunburst HCS 4825.





ENTRANCE & WINDOW SYSTEMS

NOTICE :

PL PREMIUM ADHESIVE MUST BE USED ON ALL BEDDING/BUTT JOINTS.

PEDIMENTS

PD 25102

- 3 1/8" Projection
- 98 1/2" Base Width
- 101 3/8" Top Width
- 25 1/2" Height



PWH 4421

- 44" Base Width
- 21 3/4" Height

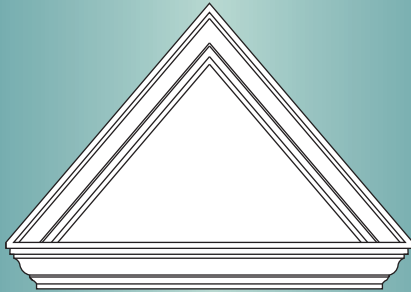

- PD 3643** • 43 3/4" Base Width
• 51 3/8" Width • 36 1/8" Height



- MD 1207** • This moulding can be used to make returns on PD 3643

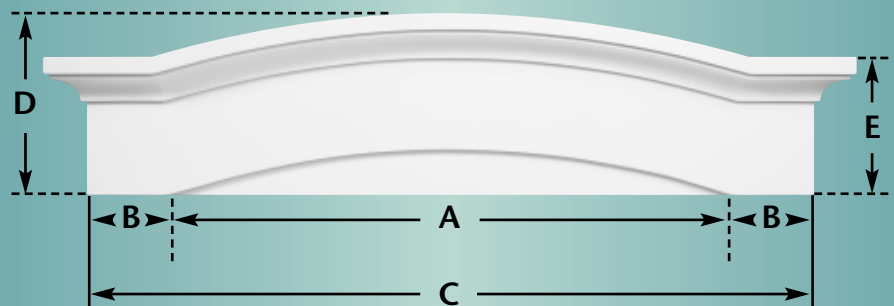

PRODUCT NUMBER	Dimensions					Projection	Breastboard Thickness
	A	B	C	D	E		
WH 33-100	33 1/2"	4 1/2"	42 1/2"	10 3/8"	8"	3 1/4"	1 1/2"
WH 33-101	29 1/2"	4 1/4"	38"	11 1/16"	8"	3 5/16"	1 9/16"
WH 34-100	42"	6 1/2"	55"	11 5/8"	8"	6 1/4"	4 1/2"

ARCHES

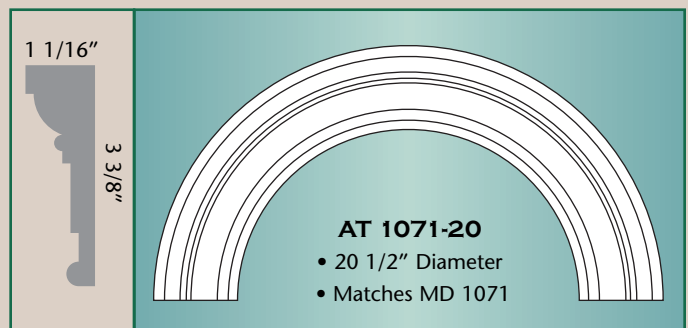
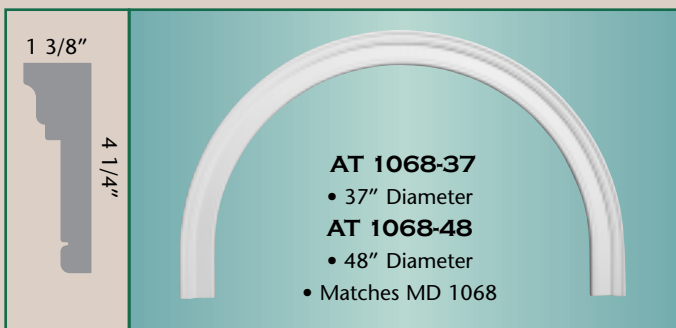
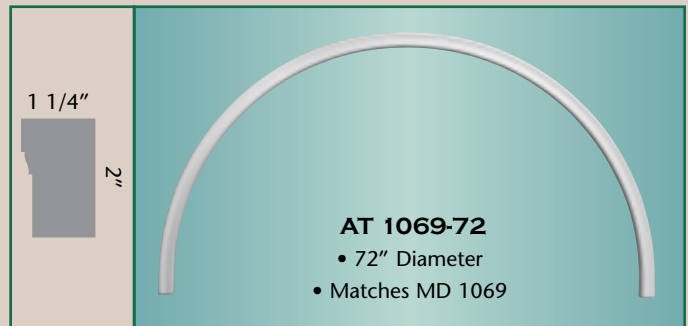

1 • 800 • 685 • 9981



ENTRANCE & WINDOW SYSTEMS



ARCHES

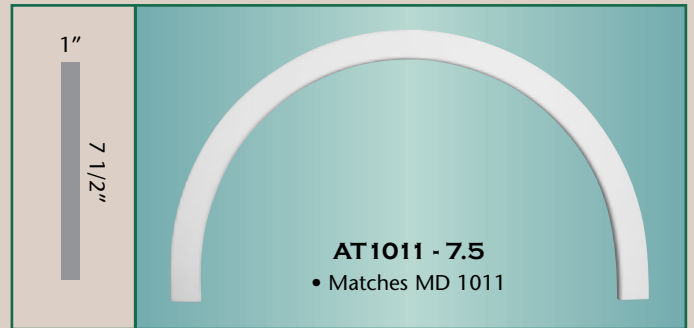
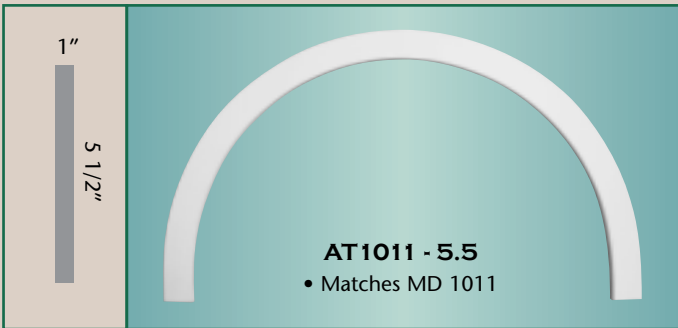
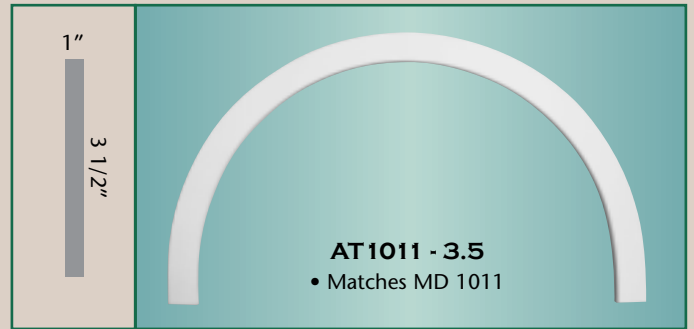
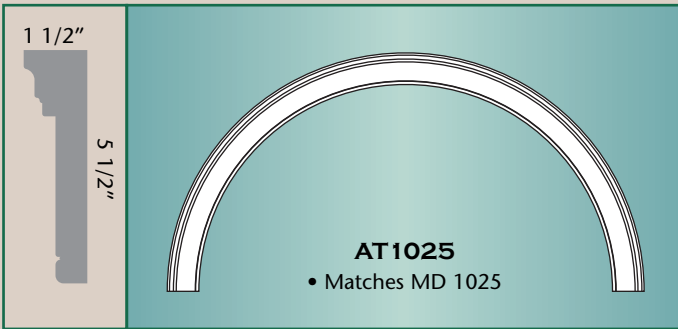
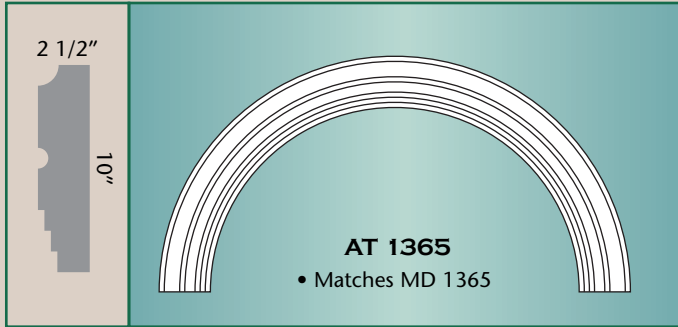

INSIDE DIAMETER	ARCH NUMBERS					
21"	AT 1365 - 21	AT 1144 - 21	AT 1025 - 21	AT 1011-3.5 - 21	AT 1011 - 5.5 - 21	AT 1011 - 7.5 - 21
24"	AT 1365 - 24	AT 1144 - 24	AT 1025 - 24	AT 1011-3.5 - 24	AT 1011 - 5.5 - 24	AT 1011 - 7.5 - 24
28"	AT 1365 - 28	AT 1144 - 28	AT 1025 - 28	AT 1011-3.5 - 28	AT 1011 - 5.5 - 28	AT 1011 - 7.5 - 28
30"	AT 1365 - 30	AT 1144 - 30	AT 1025 - 30	AT 1011-3.5 - 30	AT 1011 - 5.5 - 30	AT 1011 - 7.5 - 30
32"	AT 1365 - 32	AT 1144 - 32	AT 1025 - 32	AT 1011-3.5 - 32	AT 1011 - 5.5 - 32	AT 1011 - 7.5 - 32
36"	AT 1365 - 36	AT 1144 - 36	AT 1025 - 36	AT 1011-3.5 - 36	AT 1011 - 5.5 - 36	AT 1011 - 7.5 - 36
40"	AT 1365 - 40	AT 1144 - 40	AT 1025 - 40	AT 1011-3.5 - 40	AT 1011 - 5.5 - 40	AT1011 - 7.5 - 40
48"	AT 1365 - 48	AT 1144 - 48	AT 1025 - 48	AT 1011-3.5 - 48	AT 1011 - 5.5 - 48	AT 1011 - 7.5 - 48
60"	AT 1365 - 60	AT 1144 - 60	AT 1025 - 60	AT 1011-3.5 - 60	AT 1011 - 5.5 - 60	AT 1011 - 7.5 - 60
68"	AT 1365 - 68	AT 1144 - 68	AT 1025 - 68	AT 1011-3.5 - 68	AT 1011 - 5.5 - 68	AT 1011 - 7.5 - 68
76"	AT 1365 - 76	AT 1144 - 76	AT 1025 - 76	AT 1011-3.5 - 76	AT 1011 - 5.5 - 76	AT 1011 - 7.5 - 76
MATCHING KEYSTONES						
	K 2726	K 2711	K 2703	K 2729	K 2730	K 2731





ENTRANCE & WINDOW SYSTEMS

NOTICE :

PL PREMIUM ADHESIVE MUST BE USED ON ALL BEDDING/BUTT JOINTS.

CUSTOM ARCH WITH FLANKERS QUOTE FORM

Company: _____ City/State/Zip: _____
 Contact Name: _____ Phone: _____
 Address: _____ Fax: _____
 _____ Date: _____

ARCH OPTION
(Choose one only)

<input type="checkbox"/> AT 1011-3.5 • 1" Projection • 3.5" Height	<input type="checkbox"/> AT 1144 • 1 3/4" Projection • 5 1/2" Height
<input type="checkbox"/> AT 1011-5.5 • 1" Projection • 5.5" Height	<input type="checkbox"/> AT 1365 • 2 1/4" Projection • 10" Height



KEYSTONE
 YES NO

Fill in all dimensions

A = _____ Inches
 B = _____ Inches
 C = _____ Inches
 D = _____ Inches
 Radius = _____ Inches

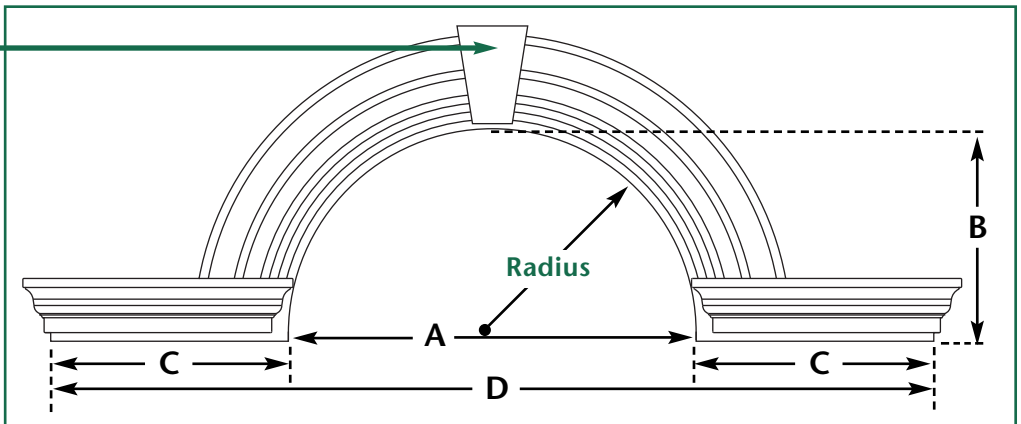

CROSSHEAD OPTION (Choose one only)

<input type="checkbox"/> CSH 1354 • 4 1/2" Projection • 9 3/4" Height	<input type="checkbox"/> CSH 1052 • 3 3/4" Projection • 6" Height
--	--

1 • 8 0 0 • 6 8 5 • 9 9 8 1



ENTRANCE & WINDOW SYSTEMS



K 2700

- 5 1/2" Projection
- 10 1/8" Height
- 8" Width
- For CSH 1015



K 2701

- 4 1/4" Projection
- 10 1/2" Height
- 8" Width
- For CSH 1035

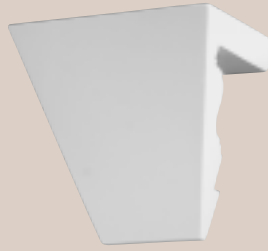

K 2702

- 4 3/4" Projection
- 7" Height
- 8" Width
- For CSH 1052



K 2703

- 2 1/2" Projection
- 6 1/2" Height
- 6" Width
- For CSH 1025

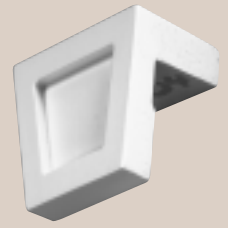

K 2704

- 2 3/16" Projection
- 2 7/8" Height
- 3 1/4" Width
- For Brick Mould

KEYSTONES



K 2705

- 2 1/2" Projection
- 7" Height
- 6" Width
- For 5 1/2" Flat Board



K 2706

- 4" Projection
- 10" Height
- 6 1/2" Width

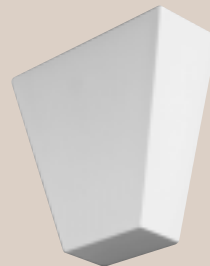

K 2707

- 3 1/2" Projection
- 7 3/4" Height
- 8 1/4" Width



K 2708

- 4 7/8" Projection
- 13 1/2" Height
- 8 3/4" Width
- For CSH 1004

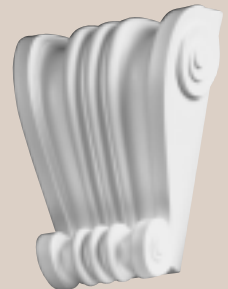

K 2709

- 5 1/4" Projection
- 14 1/4" Height
- 10 3/4" Width

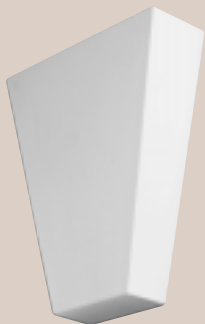

K 2710

- 4" Projection
- 13 7/8" Height
- 11 1/2" Width



K 2711

- 2 3/4" Projection
- 6 1/2" Height
- 4 1/2" Width
- For MD 1144



K 2712

- 3 1/2" Projection
- 6" Height
- 5 7/8" Width



K 2713

- 4" Projection
- 12" Height
- 6 1/2" Width
- For BL 2420

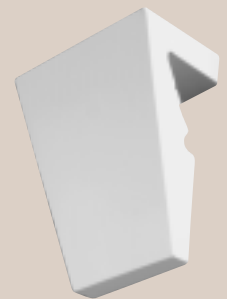

K 2714

- 4 1/4" Projection
- 7" Height
- 6" Width
- For MD 1267





ENTRANCE & WINDOW SYSTEMS

PL PREMIUM ADHESIVE MUST BE USED ON ALL BEDDING/BUTT JOINTS.

NOTICE :



Photo above shows Spectris custom window arches with keystone.



- K 2715**
- 6 1/2" Projection
 - 12" Height
 - 9 1/2" Width
 - For MD 1252



- K 2716**
- 3 1/8" Projection
 - 9" Height
 - 7 11/16" Width
 - For MD 1018

KEYSTONES

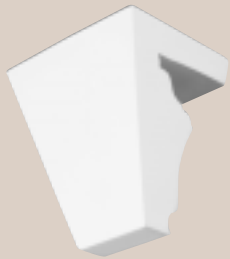

- K 2719**
- 4 1/2" Projection
 - 5 3/4" Height
 - 5 3/4" Width
 - For MD 1158



- K 2721**
- 7" Projection
 - 21" Height
 - 16" Width
 - For MD 1252

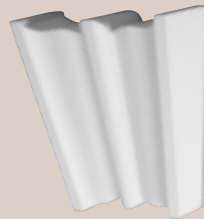

- K 2722**
- 2 7/8" Projection
 - 7 3/4" Height
 - 7" Width

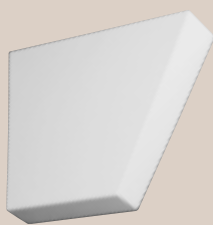

- K 2723**
- 2" Projection
 - 8" Height
 - 10" Width



- K 2724**
- 5 1/4" Projection
 - 11" Height
 - 8 1/8" Width
 - For MD 1252

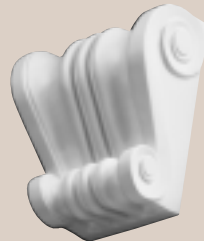

- K 2725**
- 4" Projection
 - 8 1/2" Height
 - 8 3/8" Width
 - For MD 1453

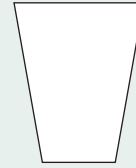

- K 2717**
- 6 1/4" Projection
 - 14 3/4" Height
 - 12" Width
 - For MD 1006

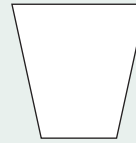

- K 2718**
- 8" Projection
 - 8" Height
 - 8" Width
 - For MD 1142



- K 2720**
- 5" Projection
 - 10 1/4" Height
 - 10" Width
 - For MD 1336

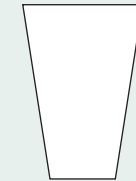

- K 2726**
- 5" Projection
 - 12" Height
 - 8 1/4" Width
 - For MD 1365

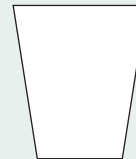

- K 2727**
- 6 3/8" Projection
 - 11 1/2" Height
 - 10" Width
 - For MD 1354

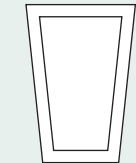

- K 2728**
- 2 3/4" Projection
 - 6 1/2" Height
 - 4 1/2" Width



- K 2729**
- 2" Projection
 - 4 1/4" Height
 - 3 1/2" Width
 - For AT 1011-3.5

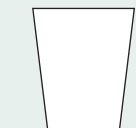

- K 2730**
- 2" Projection
 - 6 1/2" Height
 - 5 7/16" Width
 - For AT 1011-5.5

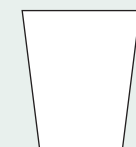

- K 2731**
- 2" Projection
 - 8 3/4" Height
 - 7 1/2" Width
 - For AT 1011-7.5

1 • 800 • 685 • 9981

